

Magneto-optical double resonance of a single NV center in diamond for photon-spin state transfer

FIRST



Naeko Niikura, Hideo Kosaka
Yokohama National University

Motivation

We demonstrate magneto-optical double resonance of a single NV center in diamond for quantum media conversion from a photon to a nuclear spin via an electron spin.

Quantum information communication

- Fundamentally secure communications
- Communication distance is : 200km (present) → >1000km (future)
- > A quantum repeater is required

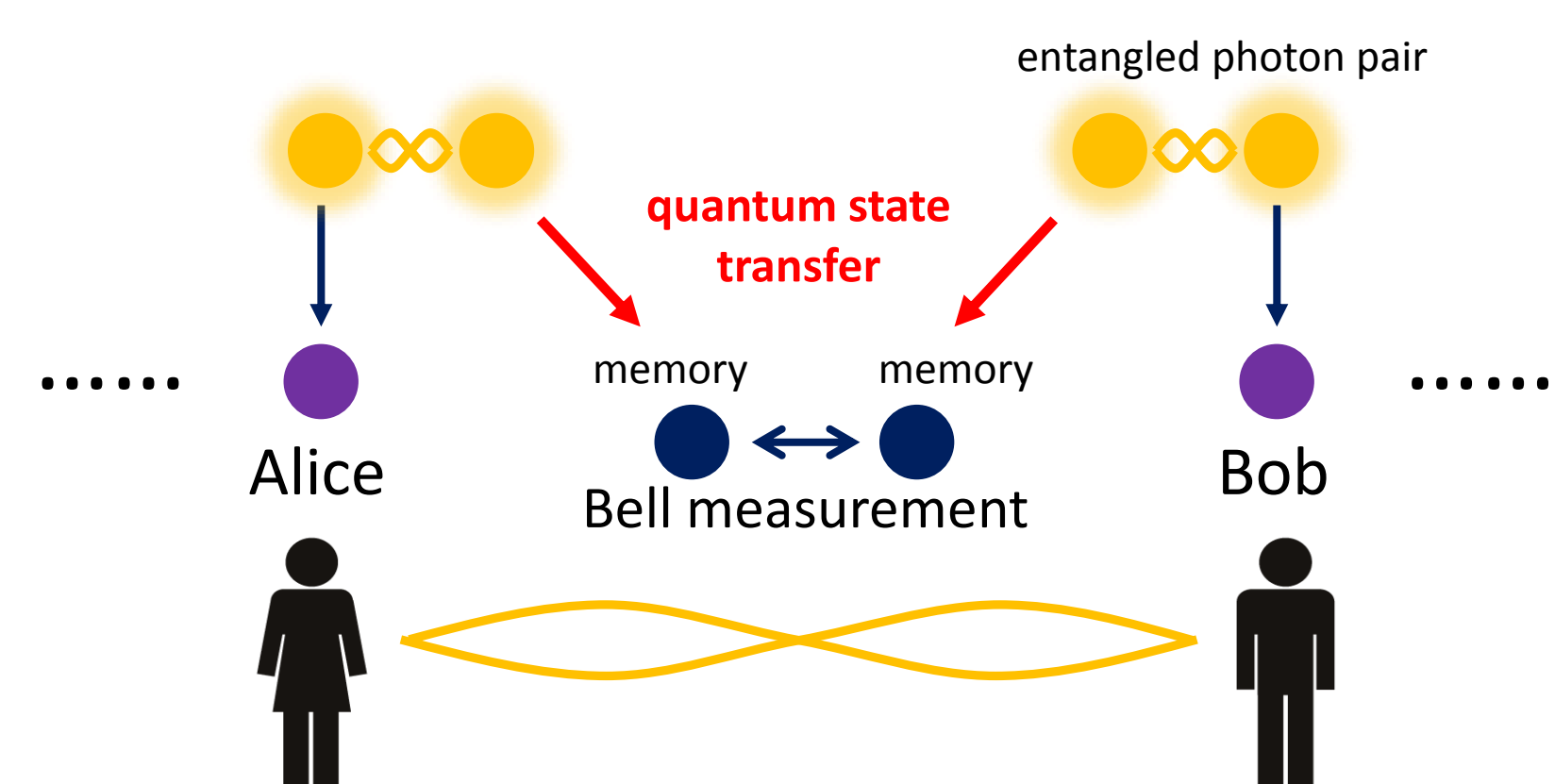

Quantum repeater

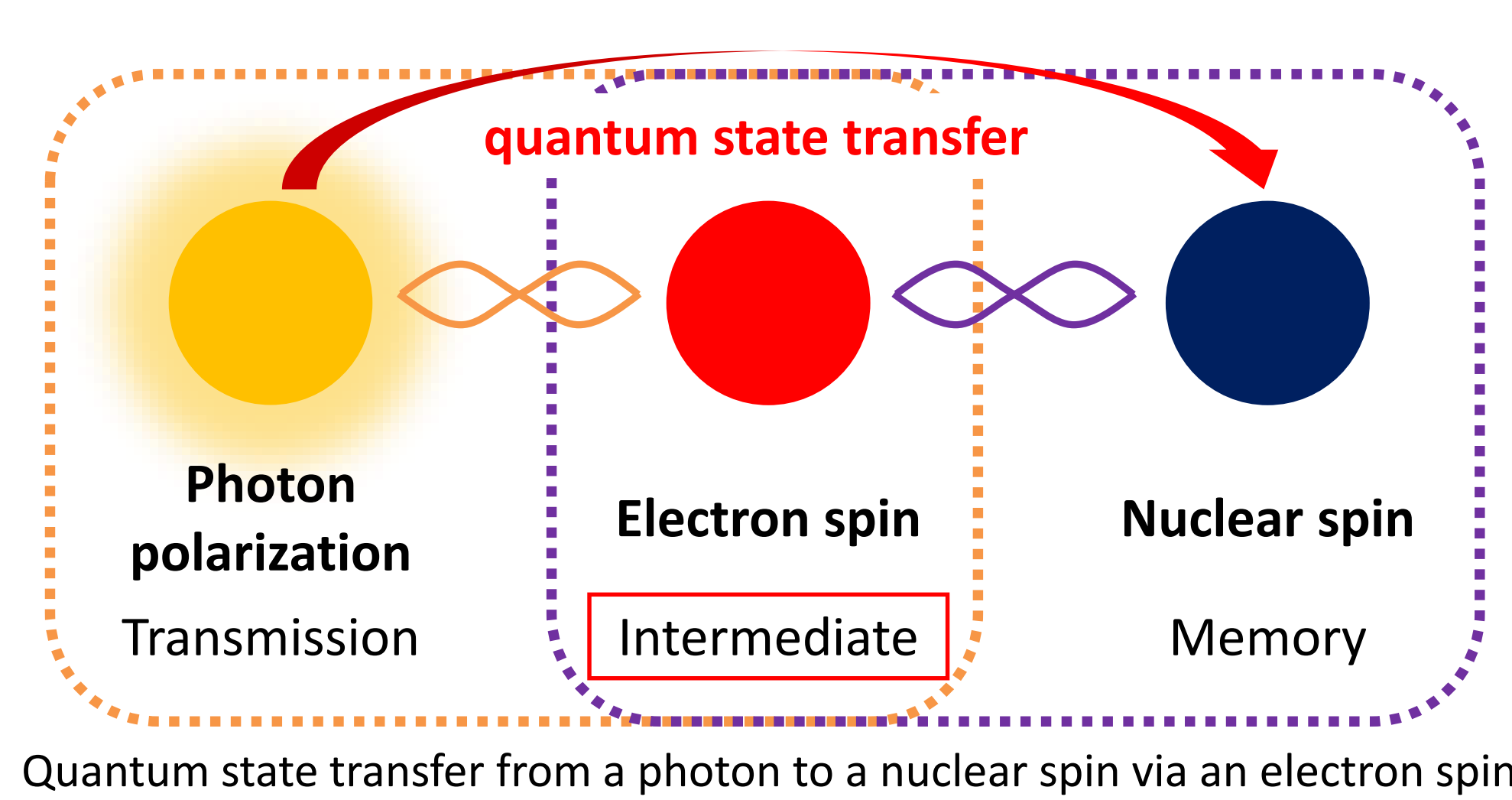

NV center in diamond

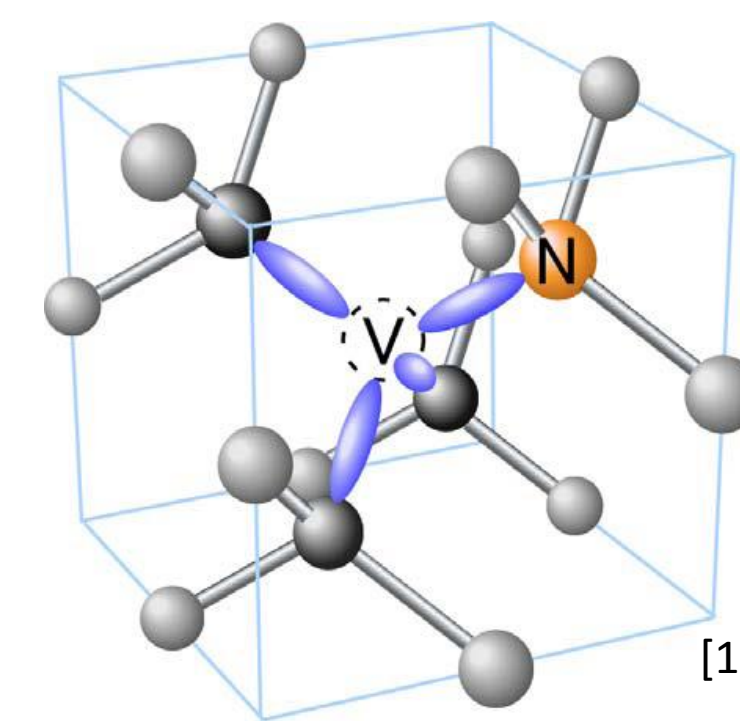

N : Nitrogen
V : Vacancy

- [1] N. Mizuochi et al., Nature Photonics 6, 299 (2012)
- [2] G. Balasubramanian et al., Nat. Mater. 8, 383 (2009)
- [3] M. V. G. Dutt et al., Science 316, 1312 (2007)
- [4] P. C. Maurer et al., Science 336, 1283 (2012)
- [5] A. Gruber et al., Science 27, 276 (1997)

- Long coherence time ($T_e^2 > 1\text{ms}$, $T_n^2 > 1\text{s}$ at RT) [2],[3],[4]
- Single electron/nuclear spin manipulation [5]
- Optical Initialization & readout of electron spins [5]

Objectives

- Excitation to $|A_2\rangle_e$ state, where orbit and spin are entangled, by magneto-optical double resonance
- Generation of electron spin coherence with microwave and its readout with light
- Transfer of photon polarization coherence to electron spin coherence

Experimental setup

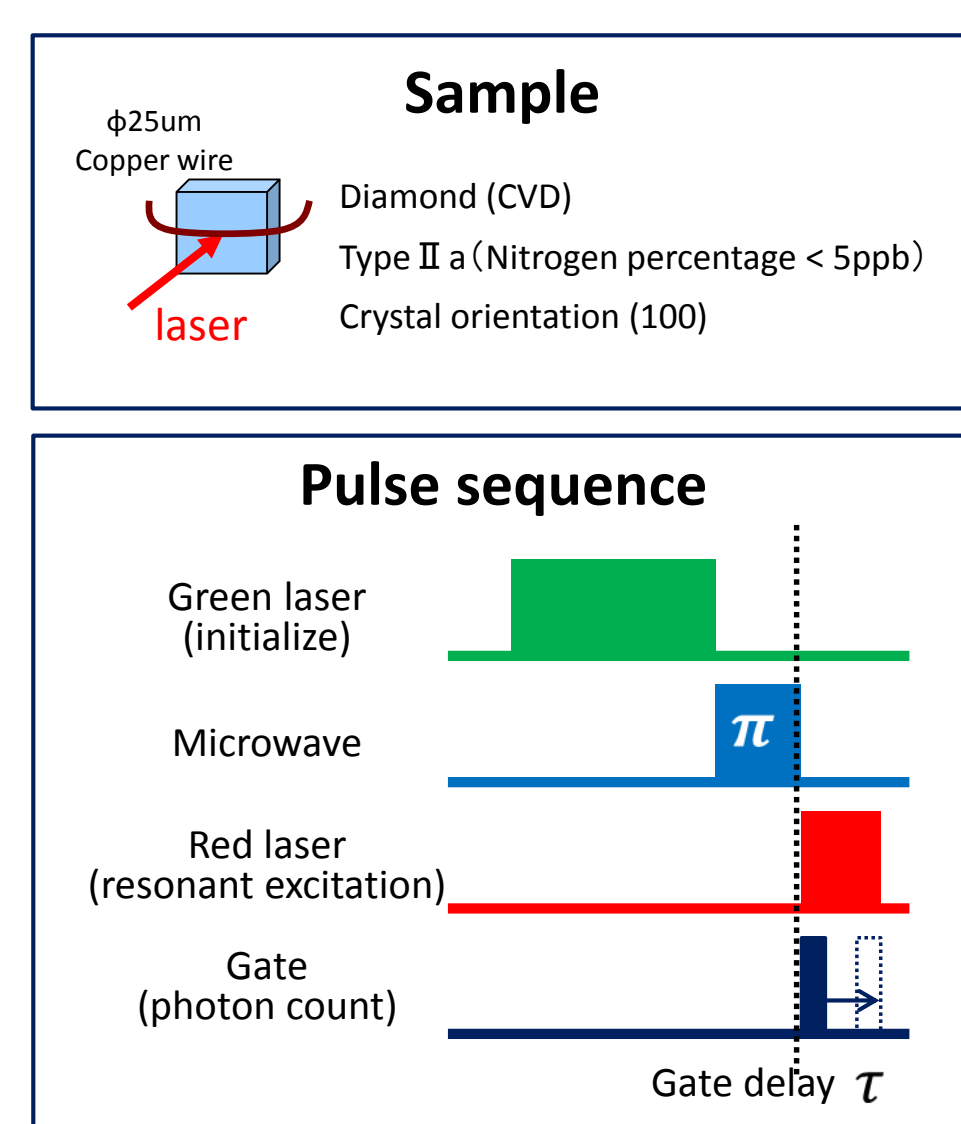
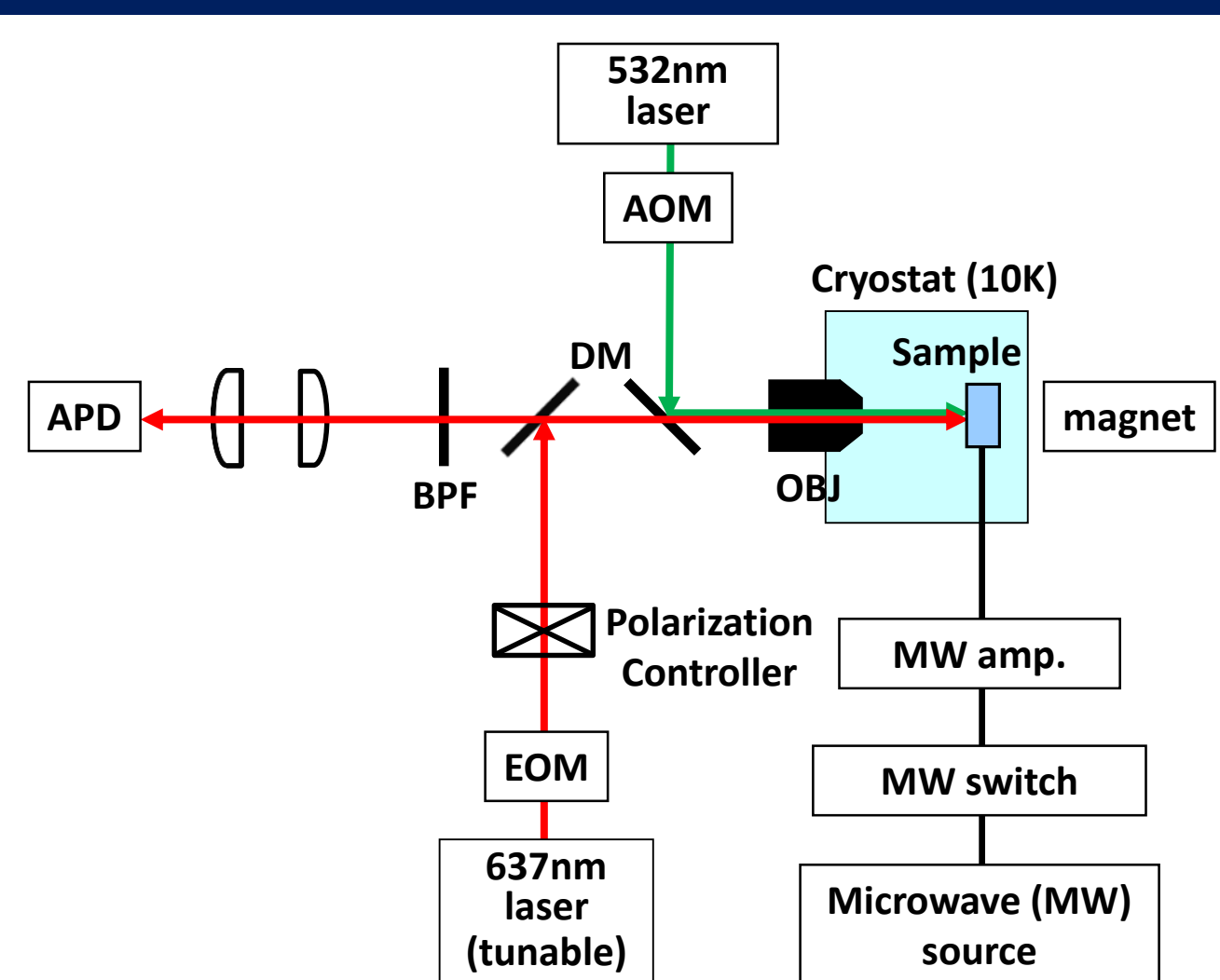

Approach

- Magneto-optical double resonance
- Degenerate Λ -v system

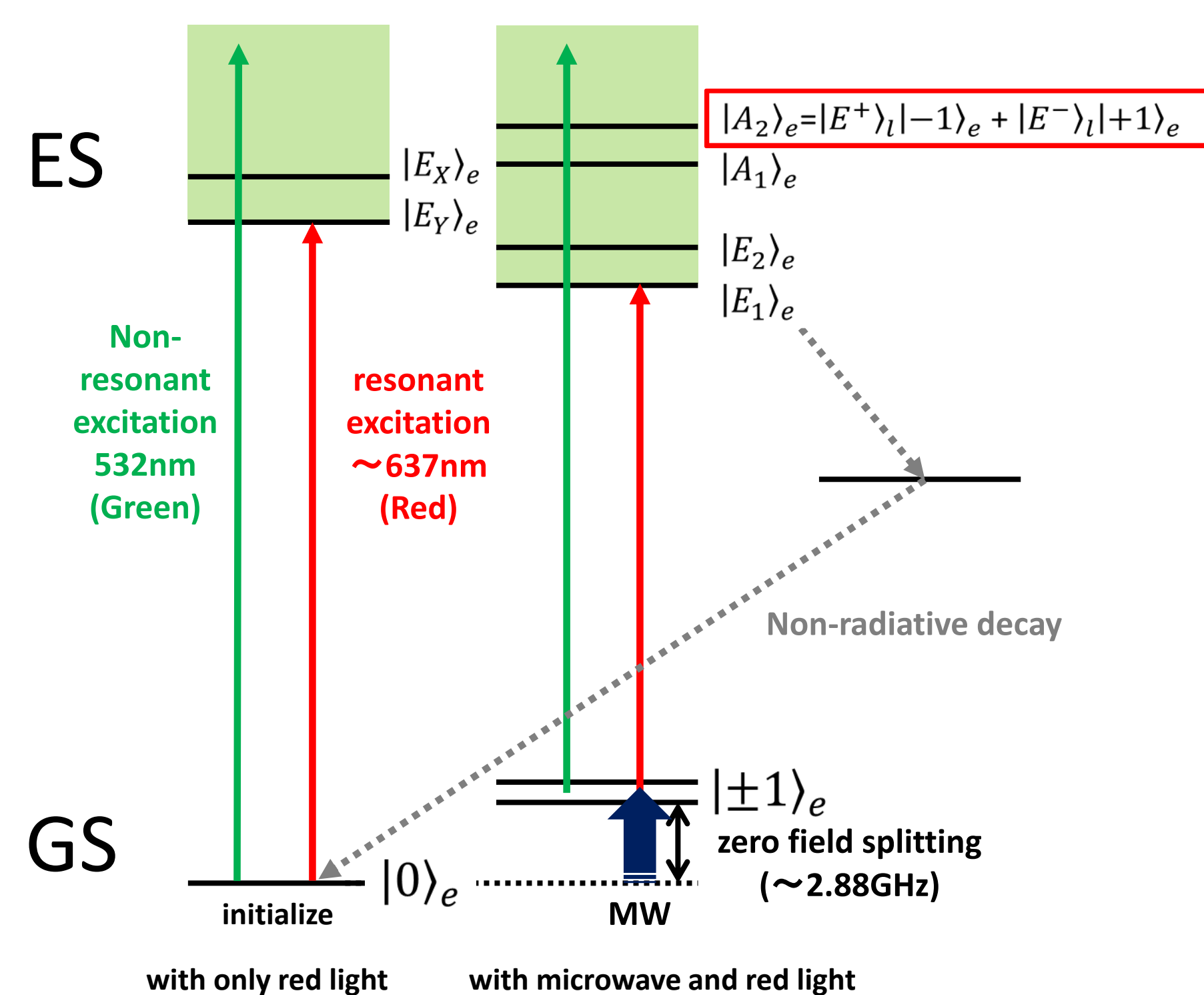
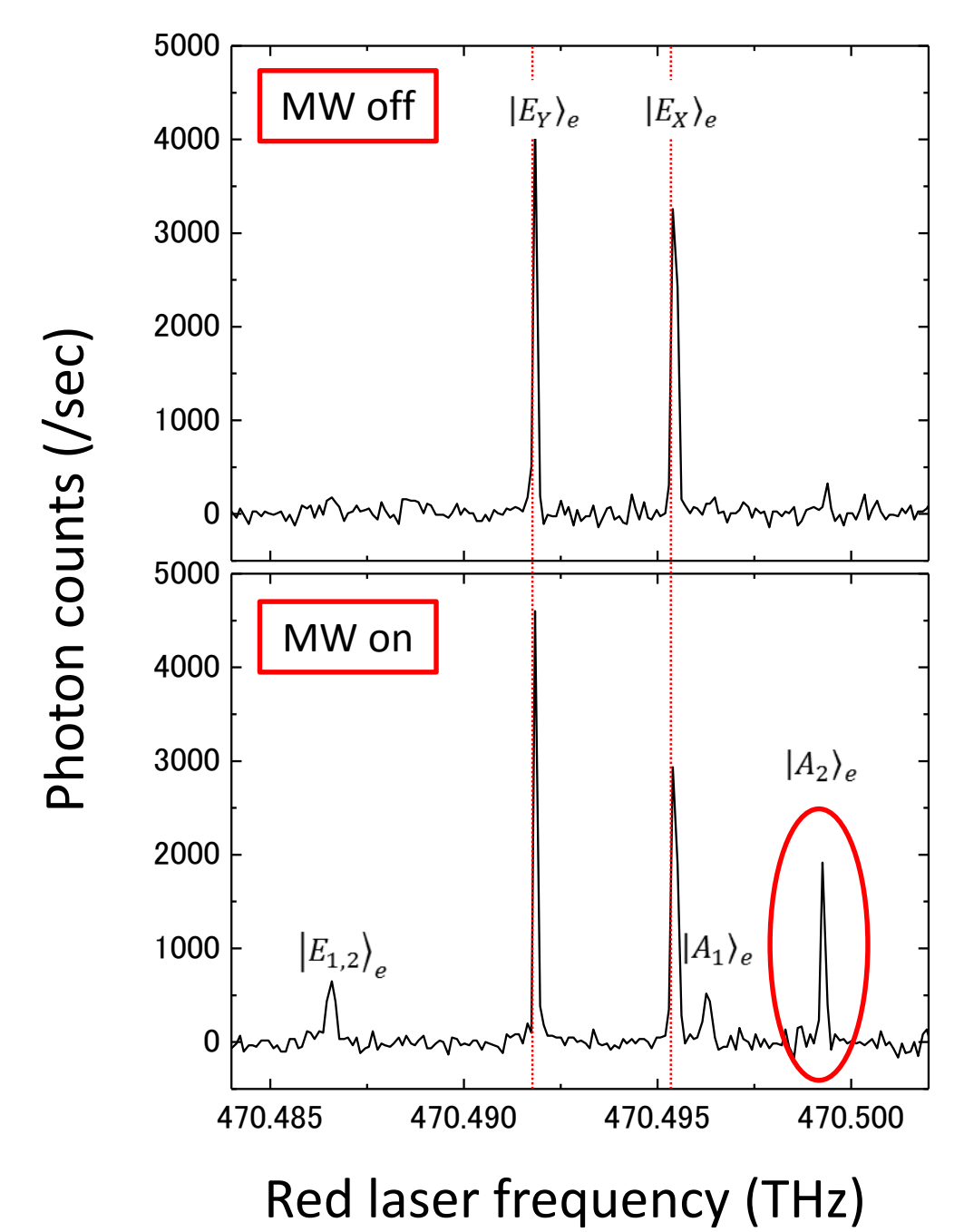

Photo-excitation spectra



Excitation to $|A_2\rangle_e$ state, where orbit and spin are entangled, was observed by magnet-optical double resonance.

Experimental results

Electron spin non-degenerate system

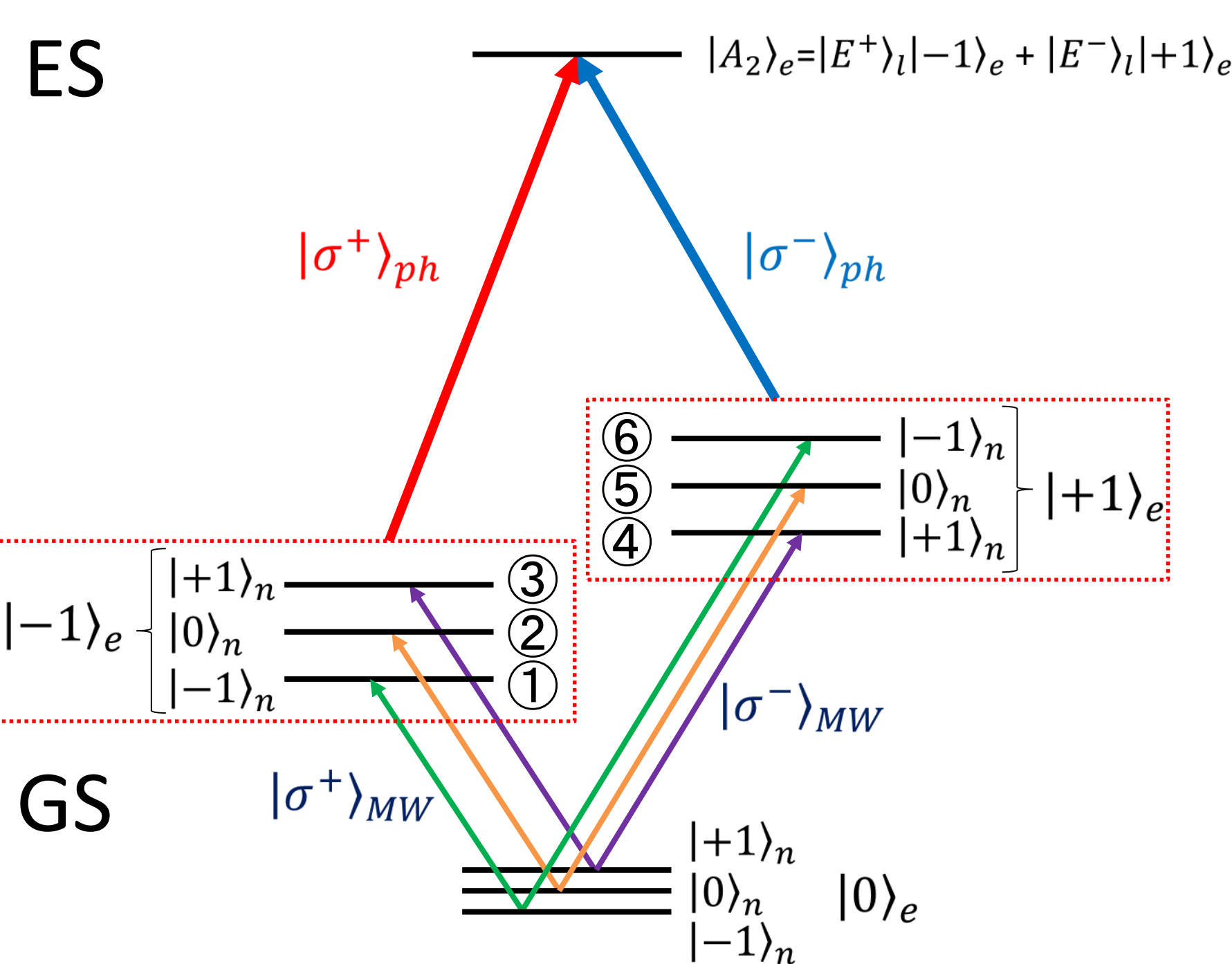

- MW frequency dependence of photoluminescence with green light (down) and with red light (up)

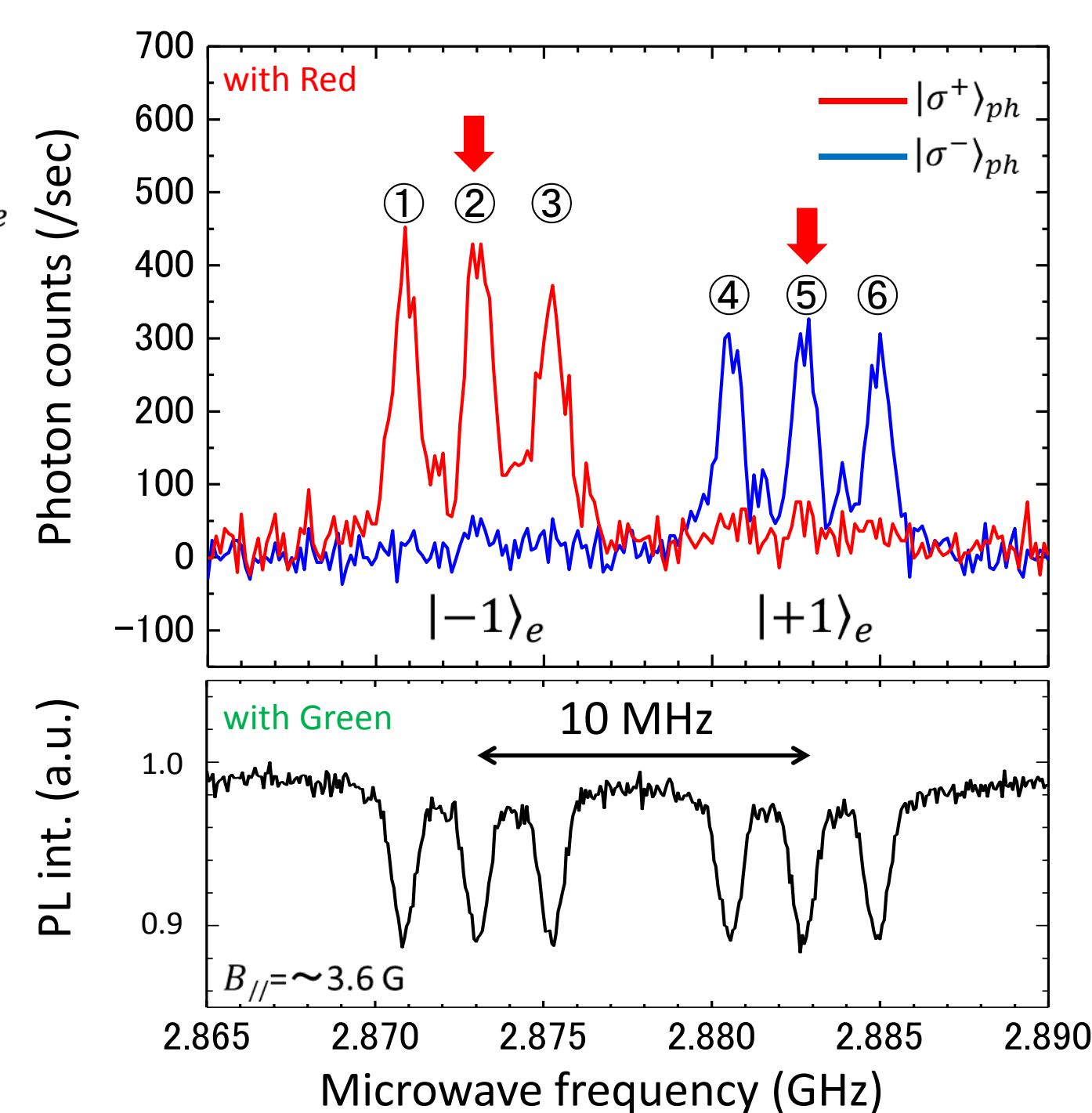

Polarization selection rule of $| -1 \rangle_e$ and $| +1 \rangle_e$ was observed by magneto-optical double resonance

Polarization dependence of photoluminescence (non-degenerate system)

- $| -1 \rangle_e \rightarrow | A_2 \rangle_e$ red light excitation

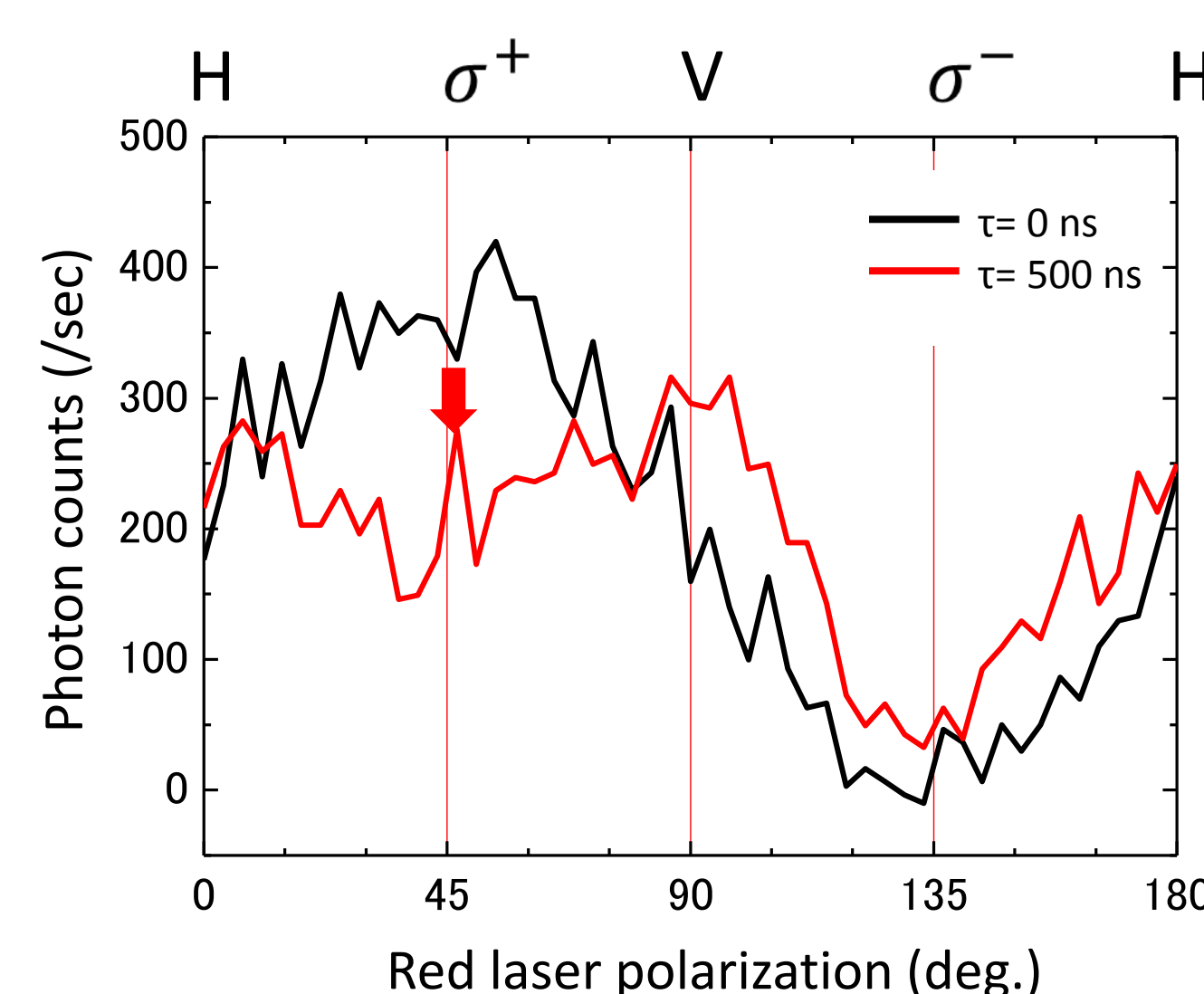

Luminescence saturation observed with $|\sigma^+\rangle$ excitation.
> Spin pumping from $| -1 \rangle_e$ to $| +1 \rangle_e$ is implied.

- $| +1 \rangle_e \rightarrow | A_2 \rangle_e$ red light excitation

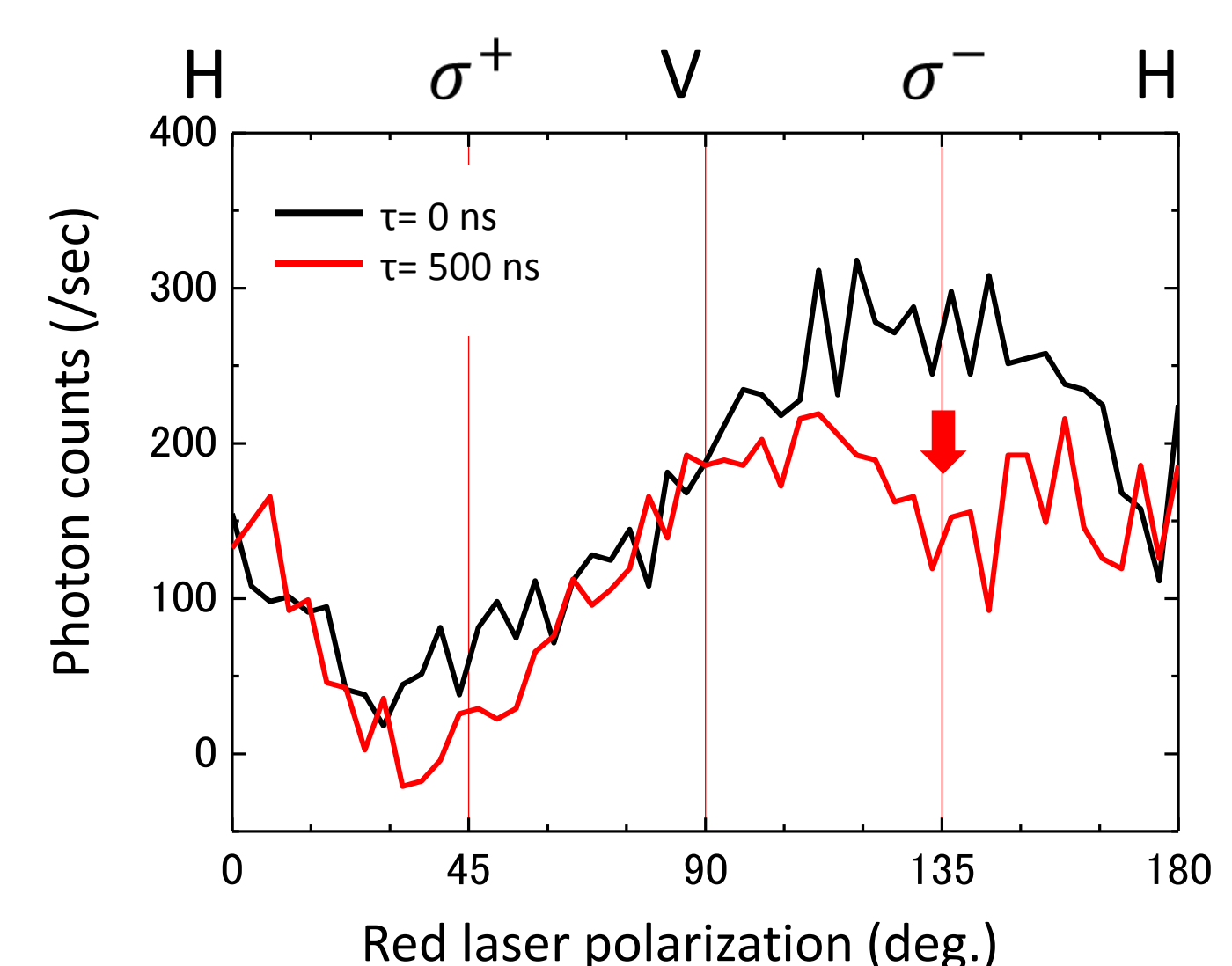

Luminescence saturation observed with $|\sigma^-\rangle$ excitation.
> Spin pumping from $| +1 \rangle_e$ to $| -1 \rangle_e$ is implied.

Electron spin degenerate system

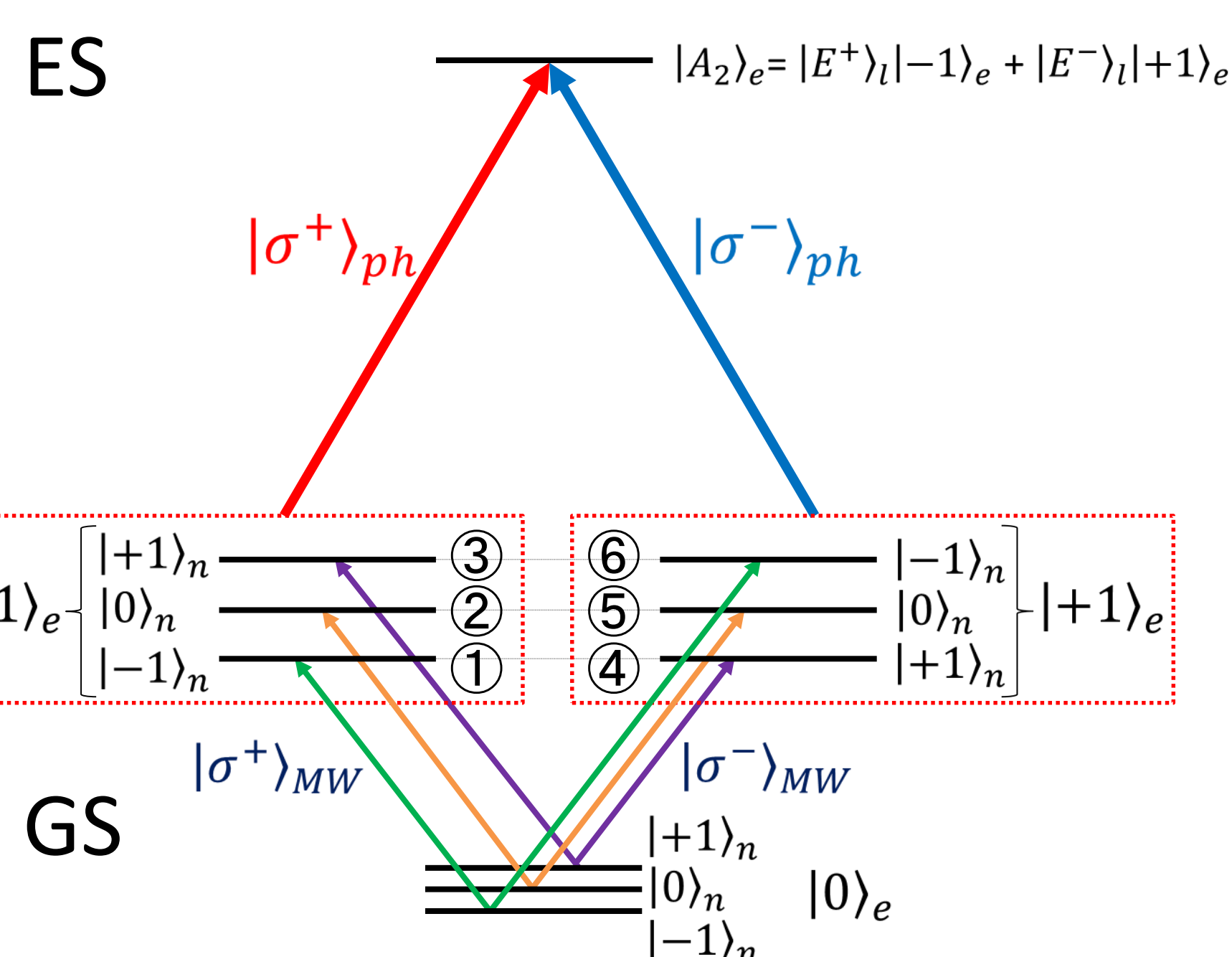

- MW frequency dependence of photoluminescence with green light (down) and with red light (up)

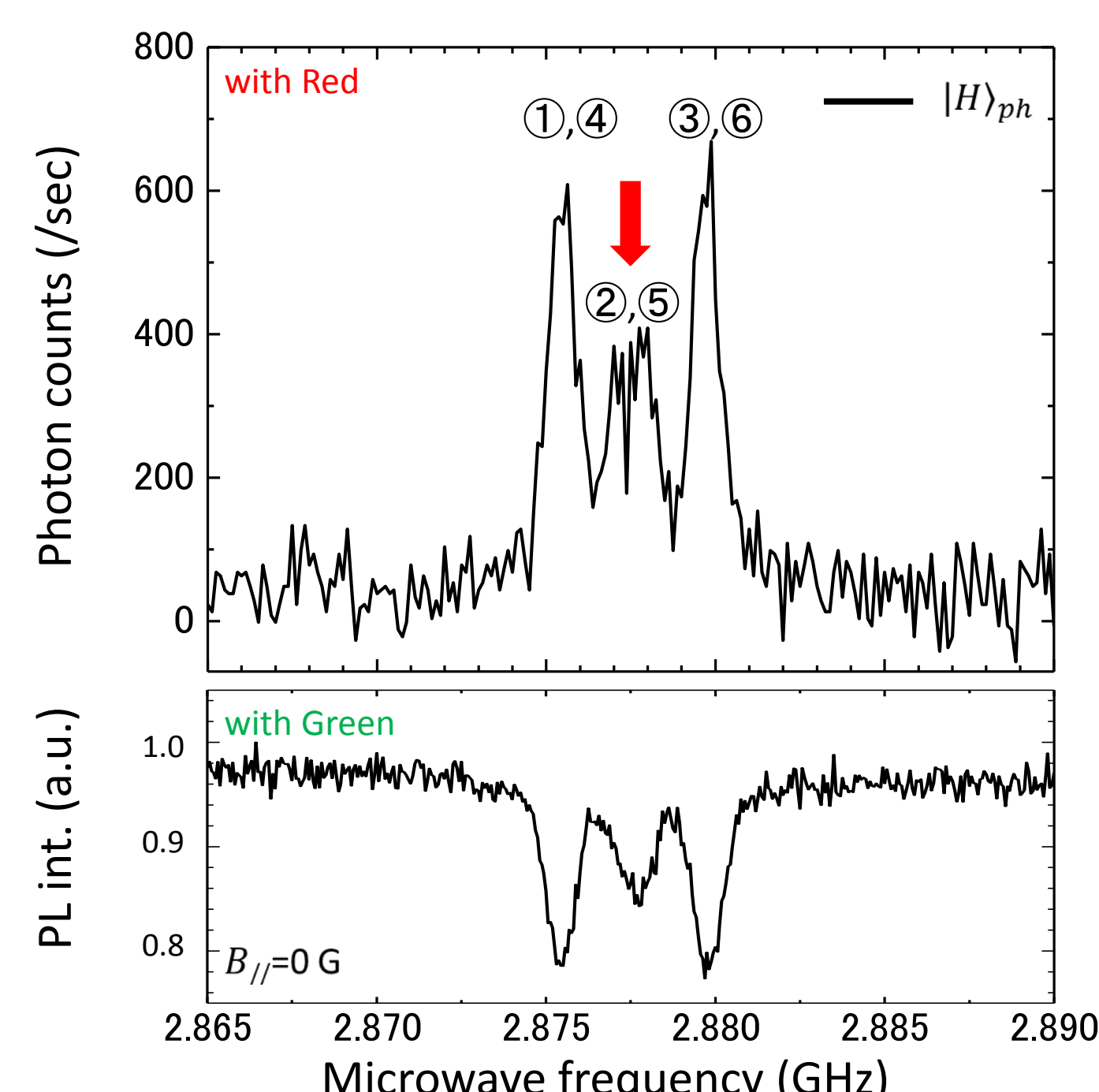

Degenerate electron spin system between $| -1 \rangle_e$ and $| +1 \rangle_e$ was created with magnetic field cancellation.

Polarization dependence of photoluminescence (degenerate system)

- $|\pm 1\rangle_e |0\rangle_n \rightarrow |A_2\rangle_e$ red light excitation

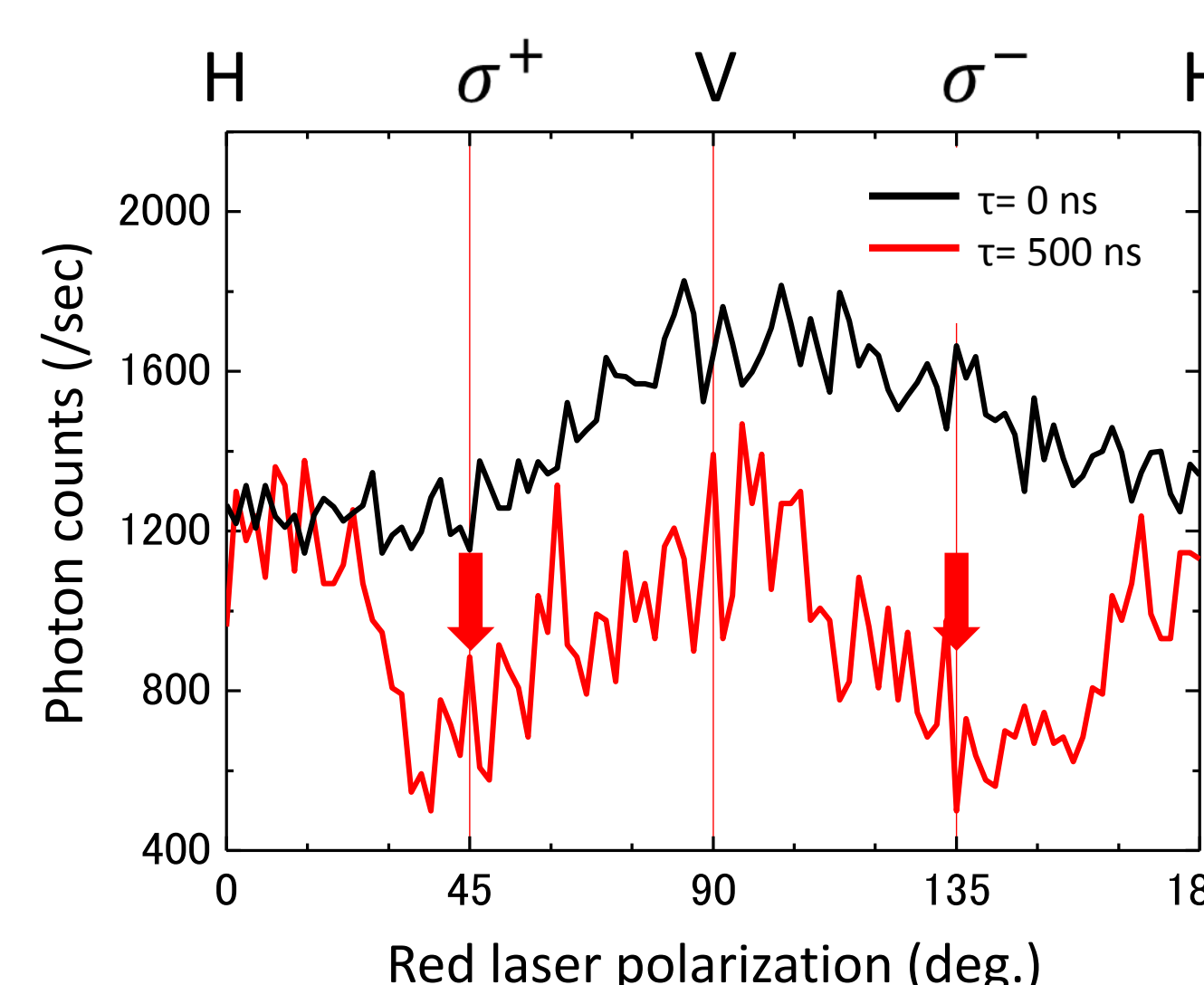

Selective excitation with $|V\rangle$ polarization was observed at $\tau = 0$ ns.
> Generation of electron spin coherence with microwave and readout by light is implied.
Luminescence saturation observed with $|\sigma^+\rangle$ and $|\sigma^-\rangle$ excitation at $\tau = 500$ ns.

- $|\pm 1\rangle_e |0\rangle_n \rightarrow |A_2\rangle_e$ Expose time dependence

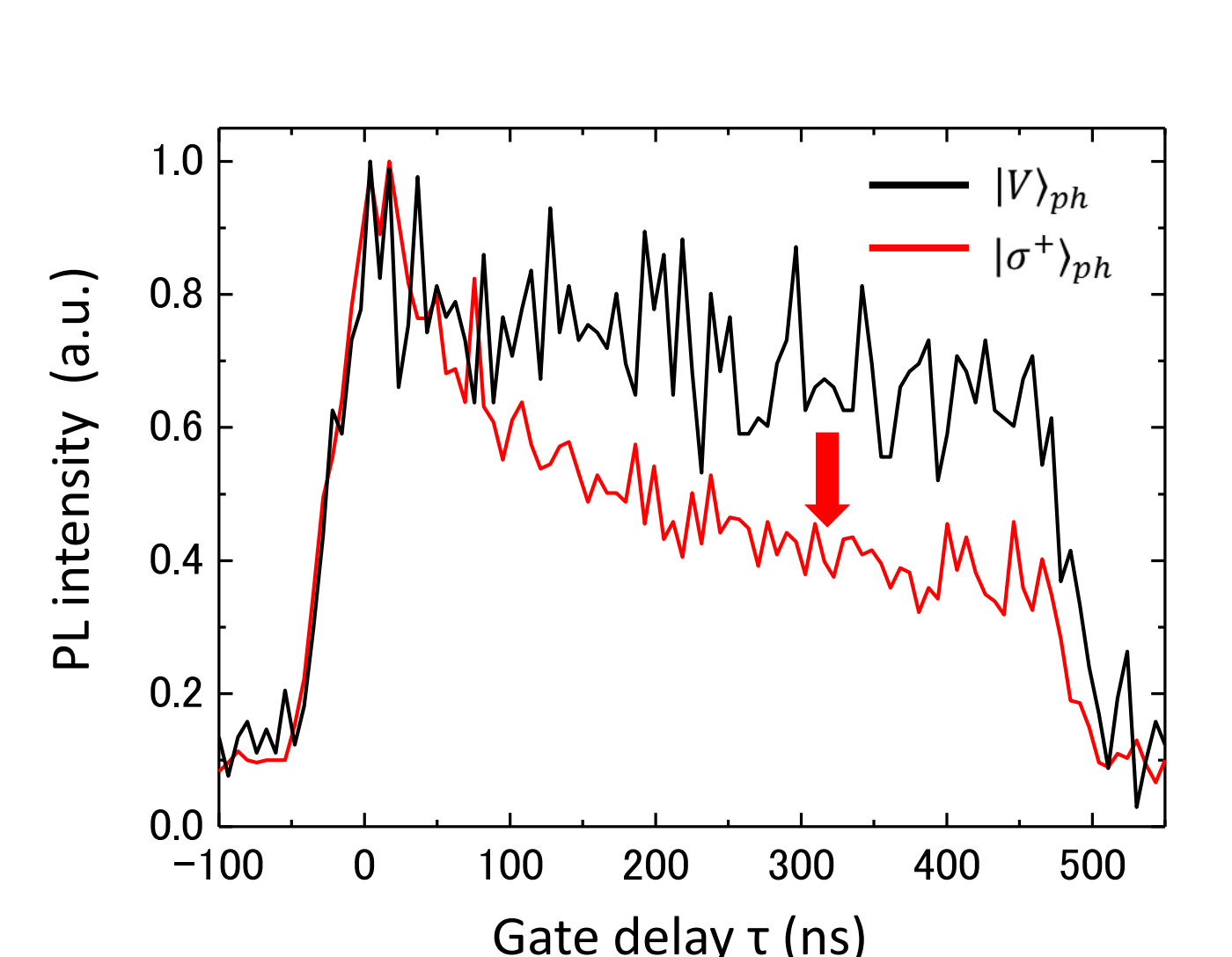

Luminescence with $|\sigma^+\rangle$ polarization decays much faster than with $|V\rangle$ polarization.
> Transfer of population from photon polarization state to electron spin state is implied.

Conclusions (status)

- Excitation to $|A_2\rangle_e$ state, where orbit and spin are entangled, by magneto-optical double resonance has been demonstrated.
- Generation of electron spin coherence with microwave and its readout with light has been achieved.
- Transfer of photon polarization population to electron spin population has been achieved.

Prospect

- Transfer of coherence from a photon to an electron spin
- Quantum state transfer of a photon polarization to a nuclear spin