

Quantum Information Research Center

<https://qic.ynu.ac.jp/en>

Quantum Information Research Center (QIC)



Foundation

October 1st, 2020

QIC was founded as a global research center within the Institute of Advanced Sciences (IAS) of Yokohama National University.

Vision

QIC is an environment where researchers in quantum information and related fields can gather, exchange information, create ideas on a day-to-day basis, and persistently launch high-value joint research projects. We aim to promote practical research and to build a reputation for carrying out world-class, large-scale research projects by participating as a core organization in national projects and joint international projects.

Team

The QIC Team is made up of professors/researchers of IAS and the Graduate School of Engineering of Yokohama National University. In addition, there are several visiting professors/researchers from other universities and National institutes who have joined QIC for project collaboration. The QIC team brings quantum information to the level together with the cooperation of students.

QIC Members

Management

PM

Center Director



Hideo Kosaka

Associate PM

Associate Professor



Anton Myalitsin

IP Strategy

Intellectual Property Producer



Kinya Kumazawa

PR International

Adjunct Teaching Staff



Annelies Volders

PR Industry-Academy-Government

Collaboration Coordinator



Yasumasa Kawasaki

Japanese Universities

Professor



Toshihiko Baba

Professor



Nobuyuki Yoshikawa

Professor



Akihiro Minamino

Associate Professor



Fumihiro Inoue

Associate Professor



Yoshihiro Shimazu

Visiting Professor



Satoshi Iwamoto



Associate Professor

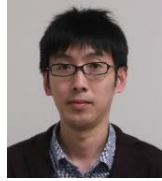

Yuki Yamanashi

Associate Professor



Yoshiaki Nishijima

Associate Professor



Christopher Ayala

Assistant Professor



Yuhei Sekiguchi

Assistant Professor



Goundar Jowesh Avisheik

Assistant Professor



Hodaka Kurokawa

Assistant Professor



Akira Kamimaki

Assistant Professor



Abdul Nasir Kuzhiyan Thadathil

Assistant Professor



Teruyuki Kinno

YNU YOKOHAMA National University

National Institutes

Visiting Professor



Toshiharu Makino



Visiting Professor



Hiromitsu Kato



Visiting Professor



Masahiro Nomura



Visiting Professor



Tokuyuki Teraji



Visiting Professor



Hirotaka Terai



Visiting Associate Professor



Kazuki Koshino



Visiting Professor

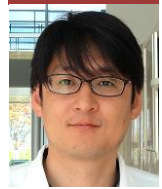

Shigehito Miki



Visiting Associate Professor



Shinobu Onoda



Visiting Researcher



Ryo Sasaki



International Members

Visiting Professor



Jonathan Finley



Visiting Professor



Kai Mueller



Visiting Professor



Fedor Jelezko



Visiting Professor



Christoph Becher



will be part of the Advisory Board

Company

Visiting Professor



Yu Mimura
FURUKAWA ELECTRIC

Visiting Associate Professor



Mamiko Kujiraoka

TOSHIBA

Project Overview

Moonshot R&D

Goal 6 : Realization of a fault-tolerant universal quantum computer that will revolutionize economy, industry, and security by 2050

Development of Quantum Interfaces for Building Quantum Computer Networks (QuINT)

- PM & PI: Hideo Kosaka
- FY 2020 - 2025
- Ministry: Cabinet Office (CAO)
- Funding Agency Goal 6: Japan Science and Technology Agency (JST)
- Project Implementation: Quantum Information Research Center

YNU | UTokyo | AIST | NIMS | QST |
RIKEN | NICT | KyotoU | TMDU



MIC

Research and development for construction of a global quantum cryptography network

Quantum Repeater Technology (QuREP)

- Coordinator & PI: Hideo Kosaka
- FY 2020 - 2024
- Ministry: Ministry of Internal Affairs and Communications (MIC)
- Project Implementation: Quantum Information Research Center

YNU | UTokyo | AIST | NIMS | NICT |
Toshiba | Furukawa Electric



Moonshot R&D

Moonshot R&D

The Moonshot Research and Development Program is a **large-scale national project** that promotes **challenging R&D projects** with the aim of **resolving difficult societal issues** while bringing together the wisdom of researchers from all over the world. The Cabinet Office has set **nine ambitious goals** to be achieved by 2050, and six of them are handled by JST.

 Cabinet Office

 Japan Science and Technology Agency

QuINT, proposed by Hideo Kosaka, got accepted as one of the twelve projects under **Goal 6**.

Goal 6 (=12 Projects)

fault-tolerant universal quantum computer



Goal 6 Milestones

2030

- Development of NISQ computers of a certain scale
- Effectiveness demonstration of quantum error correction

2040

- Demonstration of distributed NISQ computers
- Calculation of useful tasks under quantum error correction

2050

- Realization of fault-tolerant universal computers

QuINT Milestones

 **QuINT**
Quantum INterfaces



Hideo Kosaka
Project Manager

2023

- Realize a hybrid quantum interface by developing technologies such as optimal quantum light sources and quantum media conversion

2025

- Hybrid quantum interface that fuses diamond quantum memory and optomechanical crystals, enabling a quantum connection between quantum memories

2030

- Build the foundation of the quantum repeater network

Mission

Develop a quantum interface technology that connects:

1. a microwave photon to a quantum memory
2. a quantum memory to a communication photon

→ Integrate these two technologies to create a quantum interface technology between computing qubits and communication photons.

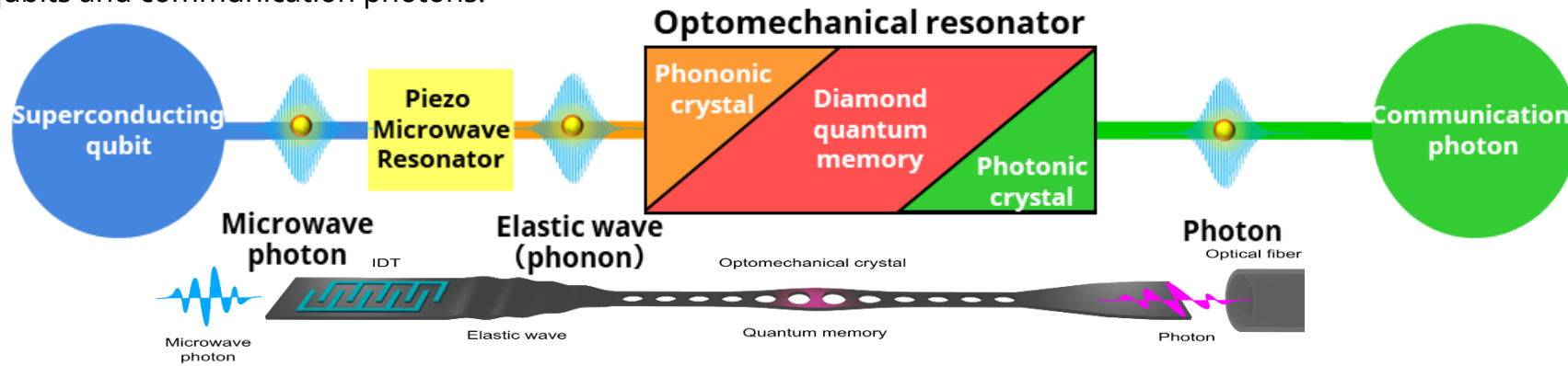

Project Management



Hideo Kosaka
(YNU)
Project Manager



Anton Myalitsin
(YNU)
Associate
Project Manager



Kinya Kumazawa
(YNU)
Intellectual
Property Producer

① Diamond Quantum Memory



Hideo Kosaka
(YNU)
Diamond Quantum
Memory



Hiromitsu Kato
(AIST)
Diamond Quantum
Structure



Tokuyuki Teraji
(NIMS)
Diamond Quantum
Crystal



Shinobu Onoda
(QST)
Diamond Color
Center

② Optomechanical Crystal



Satoshi Iwamoto
(UTokyo)
Photonic Crystal
Cavity



Toshihiko Baba
(YNU)
Photonic
Integrated Circuit



Masahiro Nomura
(UTokyo)
Phononic Crystal
Cavity

③ Piezo Microwave Resonator



Hideo Kosaka
(YNU)
Piezo Microwave
Cavity



Nobuyuki Yoshikawa
(YNU)
Qubit Control
Integrated Circuit



Kazuki Koshino
(TMDU)
Quantum Interface
Theory

R&D for Construction of a Global Quantum Crypto Network

Global Quantum Cryptography Network

The Ministry of Internal Affairs and Communications of Japan has set the goal of **constructing a global quantum cryptography** in their **Quantum Technology Innovation Policy**.

The development has been classified into **4 categories**.



QuREP is placed under **category 3** and is responsible for the total scope of this category.

1. Quantum communication - encryption link

- A) High-performance quantum cryptography
- B) Photon detection

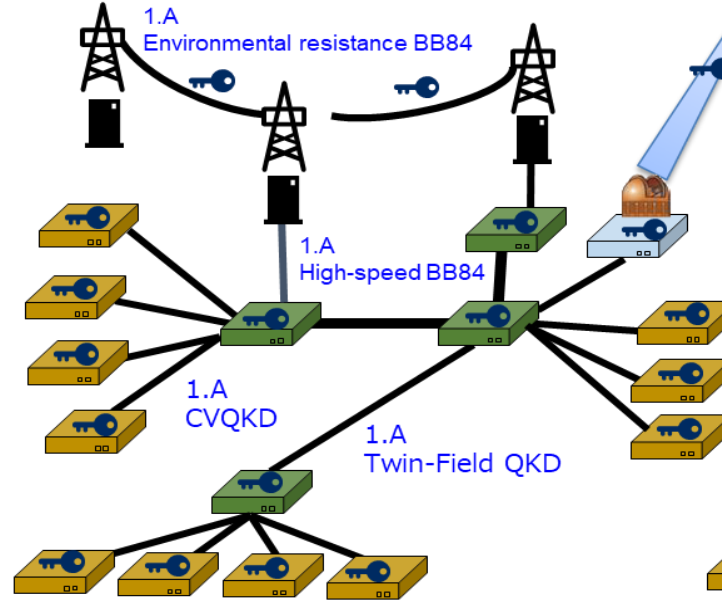

2. Trusted nodes

- A) Highly reliable key management server technologies
- B) Highly distributed technologies

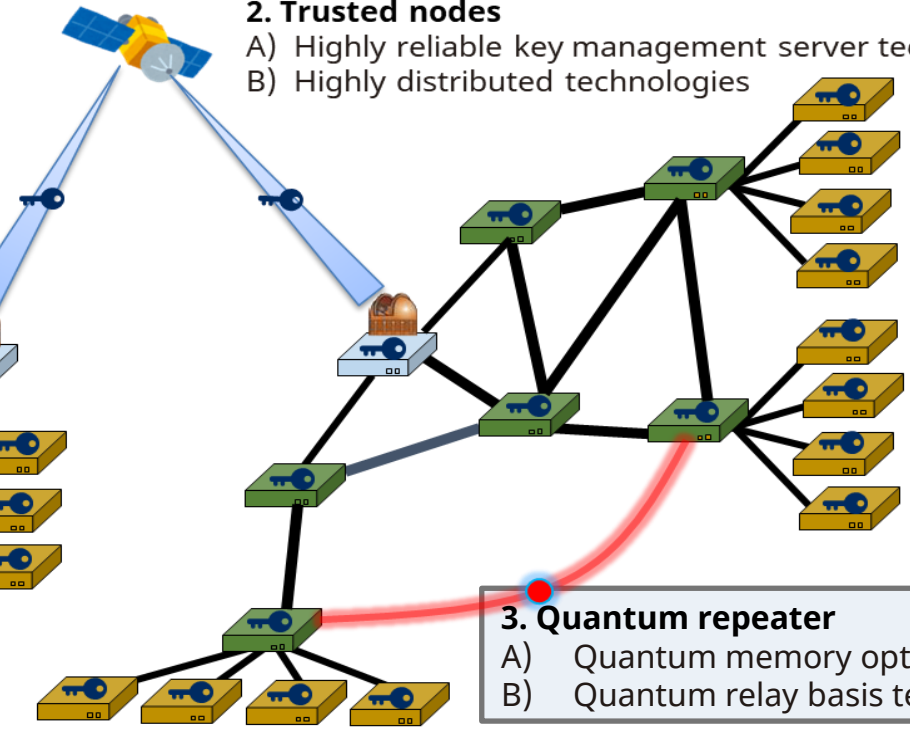

3. Quantum repeater

- A) Quantum memory optical link
- B) Quantum relay basis technologies

4. Wide-area network construction and operation

- A) Network control and management



QuREP aims to create **longer distance quantum cryptography** and a **more secure repeating of encryption keys** in terrestrial systems when compared to that of trusted nodes.

Mission

1. Develop a quantum memory technology that can maintain the quantum state at the repeater point of the network for a certain period
2. Develop peripheral devices and new fundamental technologies, such as an all-photon quantum repeater and wavelength-multiplexed quantum repeater

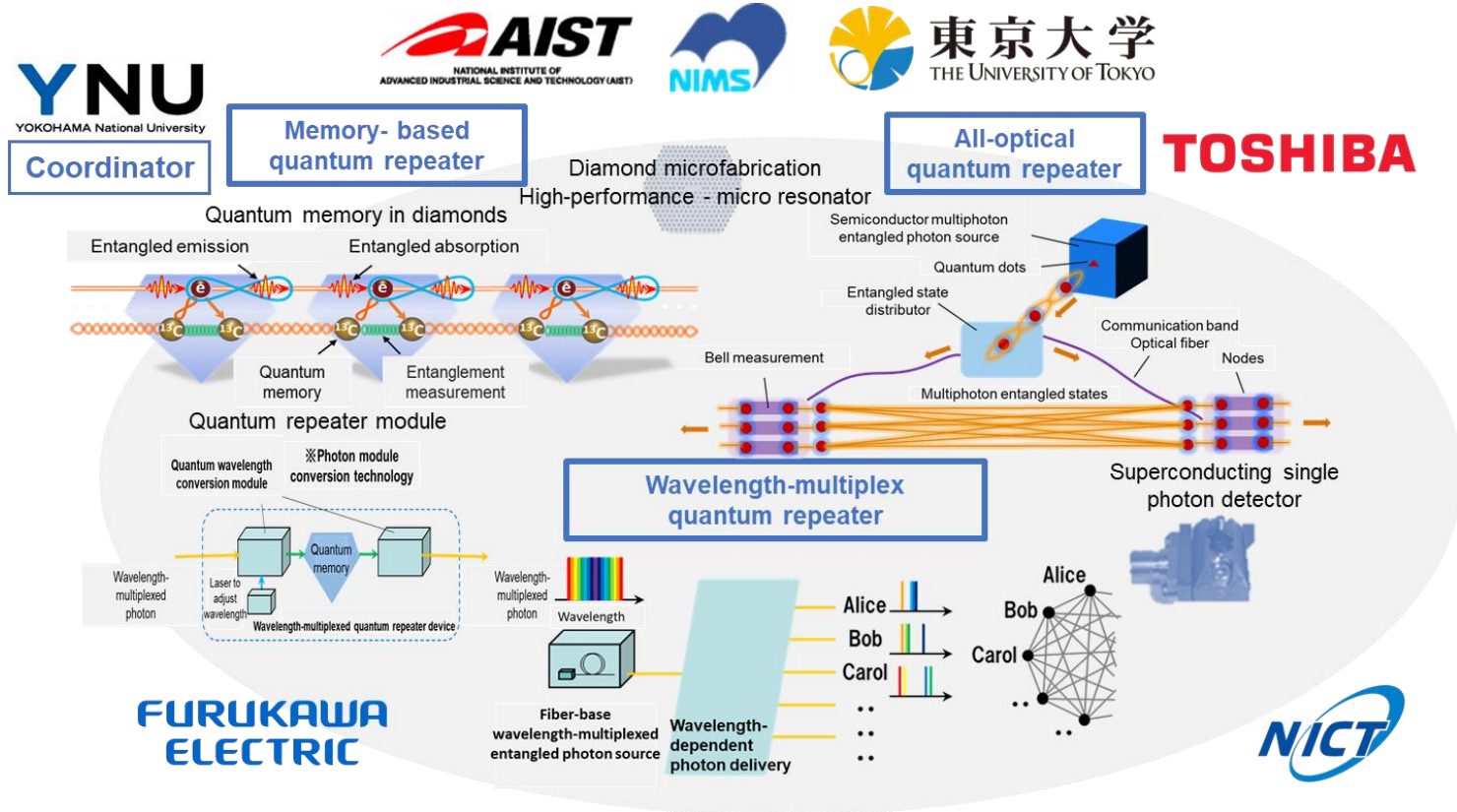

① Optical Link Technology for Quantum Memory



Hideo Kosaka (YNU)
Quantum Memory
Quantum Repeater
Technology



Hiromitsu Kato (AIST)
Diamond
Microfabrication



Tokuyuki Teraji (NIMS)
Highly-functionalized
Diamond



Satoshi Iwamoto (UTokyo)
Diamond
Microcavities

② Quantum Repeater Fundamental Technology



Mamiko Kujiraoka (Toshiba)
All-photon
Quantum Repeater



Yu Mimura (Furukawa Electric)
Wavelength-multiplexed
Quantum Repeater



Hideo Kosaka (YNU)
Quantum Memory
Photonic Interface

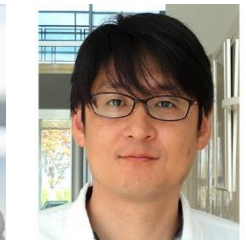

Shigehito Miki (NICT)
Superconducting
Single-photon
Detection Technology

CONTACT

WE ARE ALWAYS OPEN TO
NEW JOINT PROJECTS
AND RESEARCH VISITS

FEEL FREE TO CONTACT US AT
ias@ynu.ac.jp

WEBSITES

Kosaka Lab: kosaka-lab.ynu.ac.jp/en
QuINT: moonshot.ynu.ac.jp/en
QuREP: qurep.ynu.ac.jp/english



@Kosaka_Lab_YNU



Kosaka-lab YNU